

Mounting Brackets for Toolboxes

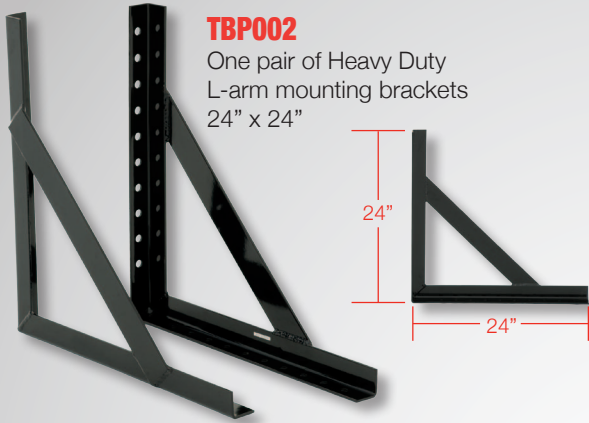

TBP002
One pair of Heavy Duty
L-arm mounting brackets
24" x 24"

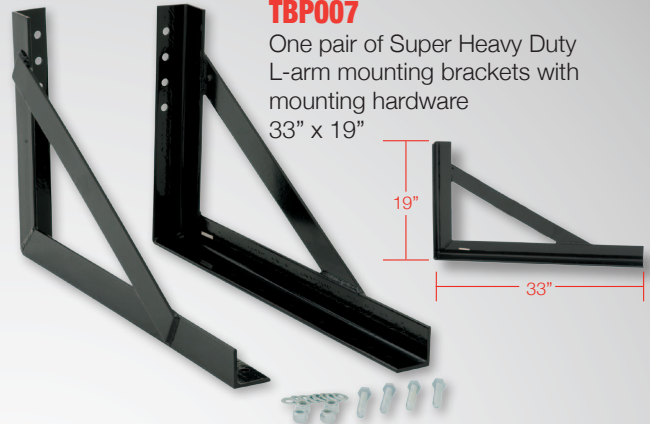
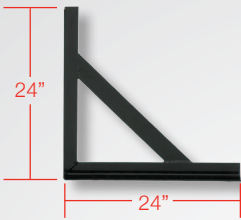

TBP007
One pair of Super Heavy Duty
L-arm mounting brackets with
mounting hardware
33" x 19"



TBP003
One pair of Heavy Duty
side-mounting brackets
27" x 6"



TBP008
One pair of Heavy Duty
L-arm mounting brackets
27" x 18"

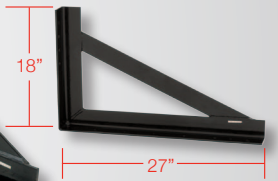

Add "GP" to part number for galvanized version.

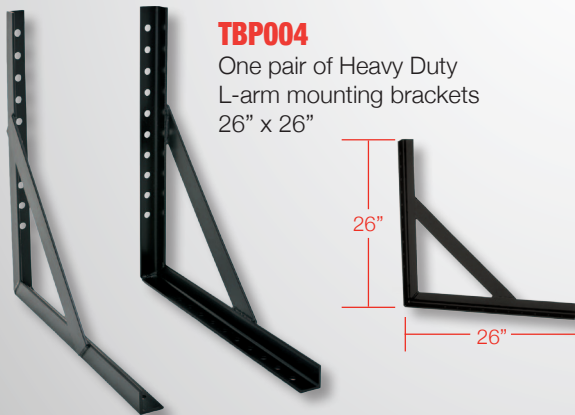

TBP004
One pair of Heavy Duty
L-arm mounting brackets
26" x 26"

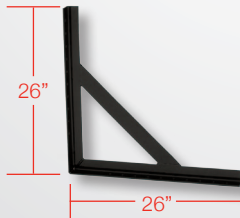

TBP011K **TBP012K**
29" L x 22"H 29" L x 17"H
Single mid-box L-arm
bracket



TBP006
Single Heavy Duty toolbox
sandwich bracket with
mounting hardware
33" x 19"

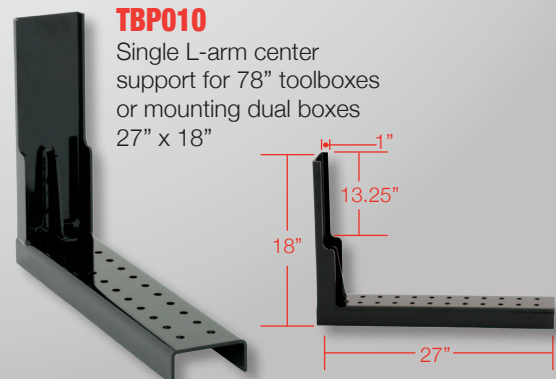
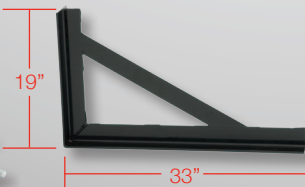

TBP010
Single L-arm center
support for 78" toolboxes
or mounting dual boxes
27" x 18"

